



E L A S T O T E C H  
elastomers technology

**Skilled. Dynamic. Smart.**



**Skilled.  
Dynamic.  
Smart.**

**WITH A  
GREEN  
CORE.**



# ENVIRONMENT

## L'AMBIENTE

### ELASTOTECH, SUSTAINABILITY GOALS

#### ELASTOTECH, OBIETTIVO SOSTENIBILITÀ

Sustainability is a business approach that is based on the creation of long-term value, which takes into consideration how the company operates in an ecological, social and economic environment. Sustainability is based on the idea that the development of these strategies allows the longevity of the company. It is therefore natural for Elastotech to adopt new actions and behaviors not only on short-term problems but also for all long-term ones.

This philosophy finds application in the various actions undertaken in the company in recent years: the most important is the achievement of ISO 14001:2015 certification, which reflects the constant commitment to reduce the environmental impact of our operations and promote responsible business practices.

Elastotech is “environment friendly”, thanks to the rational use of energy sources and the severe control on pollution, according to the latest directives. The company is equipped with a modern photovoltaic installation and wells for the water supply, which are periodically maintained to minimize environment impact.

La sostenibilità è un approccio aziendale che si basa sulla creazione di valore a lungo termine, che prende in considerazione il modo l'impresa opera in un ambiente ecologico, sociale ed economico. La sostenibilità si basa sul presupposto che lo sviluppo di tali strategie favorisca la longevità dell'azienda. È quindi naturale per Elastotech adottare nuove azioni e comportamenti non solo sui problemi a breve termine ma anche e soprattutto a quelli a lungo periodo.

Questa filosofia trova applicazione nelle diverse azioni intraprese in azienda negli ultimi anni: la più importante è l'ottenimento della certificazione ISO 14001:2015 che riflette il costante impegno nel ridurre l'impatto ambientale delle nostre operazioni e nel promuovere pratiche aziendali responsabili.

Elastotech opera nel pieno rispetto dell'ambiente, grazie all'utilizzo razionale delle fonti energetiche e al controllo sulle fonti inquinanti secondo le direttive più recenti. Per questo l'azienda è dotata di un moderno impianto fotovoltaico e di pozzi per l'approvvigionamento idrico che vengono periodicamente mantenuti in modo da limitare al minimo l'impatto con l'ambiente.





## OUR GREEN CORE



### Plastic free

Elastotech is committed to adopting internal actions and behaviors to limit the use of plastic. The awareness process that involves employees and collaborators aims to give up plastic where it is not strictly necessary: eliminating bottles and disposable plastic in the coffee break or in the company canteen as well as carrying out a scrupulous separate collection are some of the behaviors in act.

### Plastic free

Elastotech è impegnata ad adottare azioni e comportamenti interni per limitare l'utilizzo della plastica. Il processo di sensibilizzazione che coinvolge dipendenti e collaboratori ha come obiettivo quello di rinunciare alla plastica dove non è strettamente necessario: eliminare le bottigliette e la plastica usa e getta nella pausa caffè o nella mensa aziendale nonché eseguire una scrupolosa raccolta differenziata sono alcuni dei comportamenti in atto.



### Solar panels

Elastotech is equipped with a modern system of solar panels that allow the production of electricity. The roof was in fact covered entirely by 2180 photovoltaic modules for a total of 3360 square meters that use sunlight as an energy source and generate direct electricity. It is used to meet the company's energy demand.

### Pannelli solari

Elastotech è dotata di un moderno impianto di pannelli solari che permettono la produzione di energia elettrica. Il manto di copertura del tetto è stato infatti ricoperto interamente da 2180 moduli fotovoltaici per un totale di 3360 mq che utilizzano la luce solare come fonte di energia e generano elettricità a corrente continua. Essa viene utilizzata interamente ad uso interno.

### Electric mobility

Elastotech is equipped with a fleet of electric vehicles, such as cars, forklifts and scooters, powered within the company with special charging tools. The photovoltaic system on the roof produces electricity in alternating or direct current which is inserted into a recharging circuit that allows fast refueling. Fast charging columns are installed in the parking for the benefit of customers and / or operators who need to recharge their electric vehicle during the day.



### Mobilità elettrica

Elastotech è dotata di una flotta di veicoli elettrici, quali autovetture, muletti e monopattini, alimentati all'interno dell'azienda tramite appositi strumenti di ricarica. L'impianto fotovoltaico presente sul manto di copertura produce elettricità in corrente alternata o continua che viene inserita all'interno di un circuito di ricarica che consente rifornimenti veloci. Colonnine sono installate nei parcheggi aziendali a beneficio dei clienti e/o operatori che durante la loro permanenza in azienda necessitano di ricaricare il proprio veicolo elettrico.





## OUR GREEN CORE



### Smoke and dust abatement system

The Elastotech smoke and dust tower allows the regulation of gas emissions, respecting national and international standards in order to make the air quality cleaner and more preserved. This filtering system creates a work environment free of smokes, gases and fine dust.

### Impianto abbattimento fumi e polveri

La torre di abbattimento fumi e polveri di Elastotech permette la regolamentazione delle emissioni di gas, rispettando standard nazionali ed internazionali così da rendere la qualità dell'aria più pulita e preservata. Questo sistema di filtraggio e conseguente eliminazione di esalazioni nocive crea un ambiente di lavoro privo di fumi, gas e polveri sottili.



### Coalescing filter

The coalescence filter system installed by Elastotech to purify the oil mists produced during rubber processing ensures optimal efficiency in terms of separation even in the presence of truly microscopic particles, emission values below the limits set by law and also allows recovery of the liquid (in our case water) which, being reusable, will help reduce the company's waste.

### Filtro coalescenza

Il sistema di filtri a coalescenza installati da Elastotech per depurare le nebbie oleose prodotte durante la lavorazione della gomma assicura un'ottimale efficienza in termini di separazione anche in presenza di particelle realmente microscopiche, valori di emissione inferiori ai limiti previsti dalla legge e consente anche un recupero del liquido (nel nostro caso acqua) che, essendo riutilizzabile, contribuirà a ridurre gli sprechi dell'azienda.



### Recycled cardboard

Elastotech uses boxes produced with corrugated cardboard, which is a recyclable material derived from the treatment and reuse of thick sheets or multilayer rigid paper obtained from separate collection, which have been used, discarded or considered waste. This helps to significantly reduce pollution and leads to significant economic savings. In fact, the production of recycled cardboard consumes 70% less water and energy than production derived from natural resources, reducing the number of waste and CO2 emissions into the atmosphere. The carton can be reused up to 7 times.

### Cartone riciclato

Elastotech utilizza scatole prodotte con cartone ondulato, ovvero un materiale riciclabile derivato dal trattamento e dal riutilizzo di fogli spessi o di carta rigida multistrato ricavati dalla raccolta differenziata, che sono stati utilizzati, scartati o considerati rifiuti. Ciò aiuta a ridurre sensibilmente l'inquinamento e porta ad un notevole risparmio economico. La produzione di cartone riciclato infatti consuma il 70% in meno di acqua ed energia rispetto alla produzione derivata da risorse naturali, riducendo il numero dei rifiuti e le emissioni di CO2 nell'atmosfera. Il cartone può essere riutilizzato fino a 7 volte.

### Water treatment and purification

Elastotech is equipped with a water purification and treatment system to allow its reuse in the various production processes of the company. In terms of corporate sustainability, waste water is an important resource as it allows, if treated, to save costs. The system collects all the waste water of the departments in a first tank (called accumulation) and through a chemical process that separates the harmful elements from the water is completely cleaned. Finally, the same is used again within the various company processes: from the irrigation of the green areas, to the use of domestic water in the heating system up to the cooling systems of the presses and to the finishing department.

### Impianto trattamento e depurazione acque

Elastotech è dotata di un impianto di depurazione e trattamento dell'acqua per consentirne il riutilizzo nei vari processi produttivi dell'azienda. In chiave di sostenibilità aziendale le acque di scarto sono un'importante risorsa poichè permettono, se trattate, di evitare costi di smaltimento, fognatura ed acquisto. Il sistema raccoglie in una prima vasca (detta di accumulo) tutte le acque di scarico dei reparti e attraverso un processo chimico che separa gli elementi nocivi dall'acqua viene completamente chiarificata. Infine la stessa viene utilizzata nuovamente all'interno dei vari processi aziendali in base alle quantità di agenti inquinanti ed al grado di pulizia dell'acqua ottenuta: dall'irrigazione delle parti verdi, all'utilizzo di acqua sanitaria nel sistema di riscaldamento fino ad arrivare agli impianti di raffreddamento delle presse e al reparto di finitura.



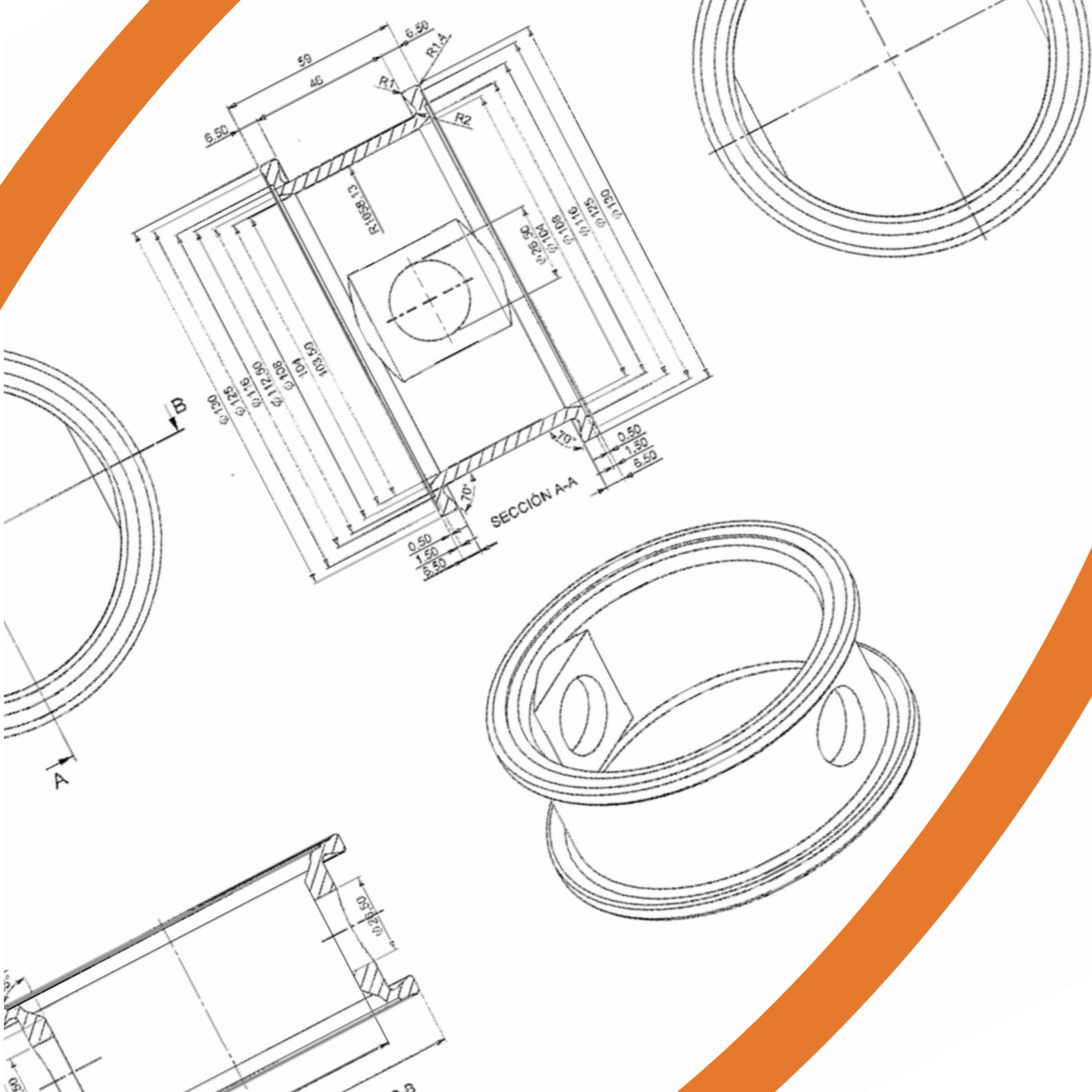

**Skilled.**  
Wide and long experience

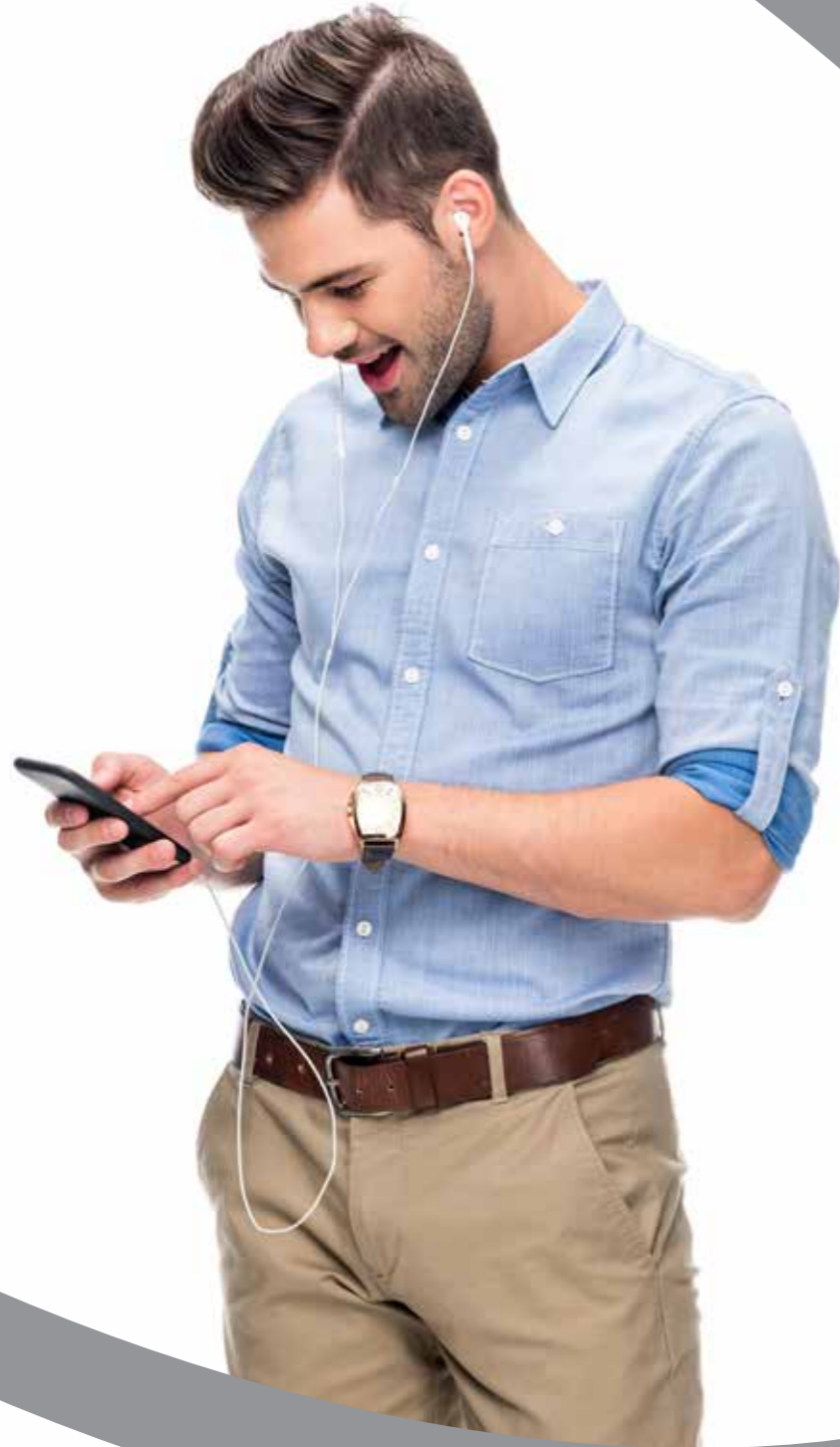

**Dynamic.**  
A young, flexible and fast approach



**Smart.**  
solid in the past, with future vision





30.000 sqm



Bergamo - Italy



Years of growth

The company Elastotech with its plant of 30,000 square meters (12,000 m<sup>2</sup> are covered) is based in Castelli Calepio (Bergamo), next to the Lake of Iseo.

Thanks to years of experience in the field of technical rubber items and o-ring, Elastotech can provide to its customer the know-how gained in the years. The recognition shown by the market allowed Elastotech to become a leader in the design and production of technical items and o-ring, in all elastomer and plastomer compounds.

L'azienda Elastotech, con il suo stabilimento di 30.000 metri quadri (12.000 sono al coperto), ha sede a Castelli Calepio (Bergamo), vicino al Lago d'Iseo.

Grazie ad anni di esperienza nel campo degli articoli tecnici ed o-ring, Elastotech può mettere a disposizione della sua clientela tutto il know-how maturato nella sua storia. Il riconoscimento dimostrato dal mercato ha permesso ad Elastotech di diventare leader nella progettazione e produzione di articoli tecnici a disegno ed o-ring, in tutte le qualità di elastomero e plastomero.



# Elàstotech /elastotek/

S.m.

Comb. ELASTOMERS e TECHNOLOGIES

*The name Elastotech comes from a combination of two terms: Elastomer and Technology, the processing of elastomers through the best technology with the goal of providing the best balance between quality and price.*

*Il nome Elastotech nasce dalla fusione dei termini **Elastomers** e **Technologies**: la lavorazione degli elastomeri attraverso l'utilizzo delle migliori tecnologie con l'obiettivo di offrire il miglior rapporto qualità prezzo possibile.*





# FROM RAW MATERIAL ... TO THE END PRODUCT

DALLA MATERIA PRIMA AL PRODOTTO FINITO

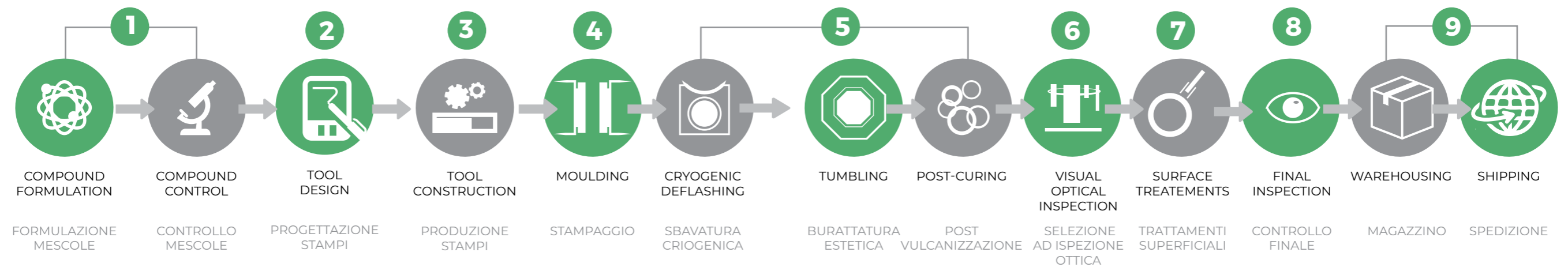
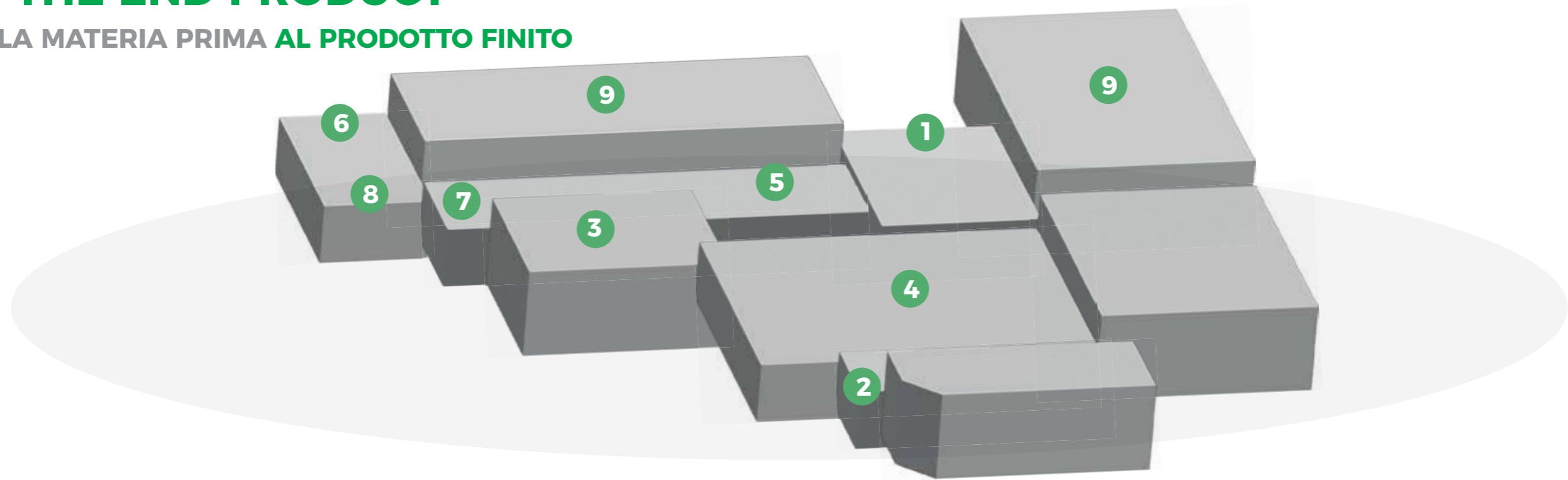



# COMPOUNDS AND CERTIFICATES OMOLOGHE E CERTIFICAZIONI

ISO 9001:2015



ISO 14001:2015



## NBR ME 0996 series

Shore: 40, 45, 50, 55, 60, 65, 70, 75, 80, 85, 90



EN549 EN681 D.M. 174/2004

## HNBR ME 0872 series

Shore: 70



EN549

## EPDM ME 0940 series

Shore: 40, 45, 50, 55, 60, 65, 70, 75, 80, 85, 90

Shore: 70



kiwa  
Upon request  
K85345/02

KTW-BWGL EN681 EN16421 3-A SANITARY ÖNORM B 5014-1

## FKM ME 0270 series

Shore: 70



EN549

## VMQ ME 2020 series

Shore: 40, 45, 50, 55, 60, 65, 70, 75, 80

Colors: red, blue, black, white, grey



EN16421 KTW-BWGL

## PTFE ME 8001 series

Available on request for contact with drinking water and food

For details about listed products please see the official listing or contact our sales department  
Per i dettagli relativi ai prodotti sopra elencati fare riferimento alle liste ufficiali o contattare il nostro ufficio commerciale



## SALES DEPARTMENT REPARTO COMMERCIALE

The Elastotech sales department is highly trained to offer a global service, not only for the Italian market, thanks to the knowledge of many foreign languages. For each project Elastotech ensures fast response and constant diligence on the customer in accordance with its needs. The staff is highly trained and focused to provide the best service with the goal to reach always higher targets.

Elastotech si avvale di un ufficio commerciale altamente qualificato per un servizio globale, non limitato al solo mercato italiano grazie alla conoscenza di numerose lingue straniere. Per ogni progetto Elastotech garantisce tempi di risposta rapidi e impegno costante verso il cliente nel rispetto delle sue esigenze. Il personale è altamente formato ed impegnato in una evoluzione continua per garantire il servizio migliore con obiettivi sempre più alti.





# LABORATORY ET LAB



**R&D  
DEPARTMENT**  
RICERCA E  
SVILUPPO



**DESIGN**  
PROGETTAZIONE



**QUALITY  
DEPARTMENT**  
CONTROLLO  
QUALITÀ

ET LAB is the beating heart of Elastotech. ET LAB is not just a laboratory, it is the place where the gasket project comes to life and where it is checked that the quality standards required by the customer are met. Feasibility analysis, definition of the most suitable compound, design and implementation of technical drawing of the tooling, cost analysis and offer creation. These are the primary tasks carried out in the lab.

But not only, ET LAB is a place of research and experimentation, of technological innovation to improve customer seals, create new ones, get us closer to the best possible production process. It is a future-oriented place, where data and statistics on internal processes are collected, new patents are studied, and knowledge is sought with the aim of making company resources grow. It is also a teaching place that allows the company to have a generational turnover for the work of tomorrow.

ET LAB è il cuore pulsante di Elastotech. ET LAB non è solo un laboratorio, è il luogo dove il progetto della guarnizione prende vita e dove viene controllato che siano rispettati gli standard qualitativi richiesti dal cliente.

Analisi di fattibilità, definizione della miscela più idonea, progettazione e realizzazione disegno tecnico dello stampo attrezzatura, analisi dei costi e formulazione dell'offerta.

Queste le mansioni primarie svolte in laboratorio. Ma non solo, ET LAB è un luogo di ricerca e di sperimentazione, di innovazione tecnologica per migliorare le guarnizioni dei clienti, crearne di nuove, avvicinarci al migliore processo produttivo possibile. È un luogo orientato al futuro, dove vengono raccolti dati e statistiche su processi interni, si studiano nuovi brevetti, si cerca di diffondere conoscenza con l'obiettivo di fare crescere le risorse aziendali. E' altresì un luogo di insegnamento che permette all'azienda di avere un ricambio generazionale per il lavoro del domani.



Our team works professionally and with knowledge in the development of new products, tool design and choice of suitable compounds, always in close contact with the customer. Our technical department designs with 2D/3D CAD-CAM programs.

Il nostro team lavora professionalmente con competenze allo sviluppo di nuovi prodotti, strumenti di progettazione e costruzione e nella scelta delle mescole adatte, sempre in stretto contatto con il cliente. Il nostro ufficio tecnico utilizza programmi 2D/3D CAD-CAM.



# RICERCA E SVILUPPO

## R&D DEPARTMENT





# DESIGN PROGETTAZIONE

To design a gasket means conceive, work on the drawings, calculations and studies necessary for its realization. Once all the sensitive data has been received, the team analyzes the feasibility of the entire project: the use of the suitable compound, the creation and realization of the technical drawing of the tool, the

simulation of the production process with the analysis of the costs that leads to the formulation of the offer. ET LAB thanks to a concentration of devices, methodologies, knowledge and experience plans and programs the entire set of activities necessary to achieve the expected result.



PROJECT FEASIBILITY ANALYSIS  
ANALISI FATTIBILITÀ PROGETTO



COMPOUND RESEARCH  
INDIVIDUAZIONE MESCOLA



TOOL DESIGN STUDIO  
STUDIO PROGETTAZIONE STAMPO



COSTS ANALYSIS  
ANALISI COSTI



OFFER CREATION  
FORMULAZIONE OFFERTA

Progettare una guarnizione significa ideare, eseguire i disegni, i calcoli, gli studi necessari alla sua realizzazione. Una volta ricevuti tutti i dati sensibili il team si occupa di analizzare la fattibilità dell'intero progetto: l'utilizzo della mescola idonea, la creazione e realizzazione del disegno tecnico dello stampo attrezzatura, la simulazione

del processo produttivo con l'analisi dei costi che porta alla formulazione dell'offerta. ET LAB grazie ad un concentrato di strumenti, metodologie, conoscenze ed esperienza pianifica e programma l'insieme delle attività necessarie per raggiungere il risultato atteso.





# QUALITY DEPARTMENT

## UFFICIO QUALITÀ



TOOL PROCESS  
MONITORING  
MONITORAGGIO  
PROCESSO STAMPI



PRODUCTION AND  
MOLDING CONTROL  
MONITORAGGIO  
PRODUZIONE/  
STAMPAGGIO



POST PRODUCTION  
FINISHING CONTROL  
MONITORAGGIO  
FINITURE/  
POST PRODUZIONE



SORTING  
CERNITA

The quality system of Elastotech is ISO 9001:2015 and iso 14001:2015 certified. The entire production process is constantly monitored by qualified personnel. Thanks to the support of latest generation instruments we guarantee and certify the severe requirements of our customers.

Il Sistema qualità Elastotech è certificato ISO 9001:2015 e ISO 14001:2015.

L'intero processo produttivo è monitorato costantemente da personale qualificato. Con il supporto di un apparato strumentale di ultima generazione garantiamo e certifichiamo i severi requisiti dei nostri clienti.

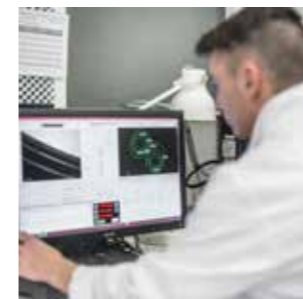



# INTERNAL WORKSHOP OFFICINA MECCANICA



**CNC MACHINING**  
LAVORAZIONE A CONTROLLO NUMERICO CONTROLLATO



**ELECTRO EROSION**  
ELETTRO EROSIONE



**CHROME POLISHING**  
LUCIDATURA / CROMATURA



**LASER ENGRAVING**  
INCISIONE LASER

Our internal workshop, designs and produce molds for o-rings, washers and items in according to customer drawing with very complex geometries and tight tolerances. Our technical staff works together with our clients from the beginning of the projects, in order to find the best solution. This department is able

L'officina costruzione stampi, ubicata all'interno di Elastotech, progetta e realizza stampi di o-ring, rondelle ed articoli a disegno con geometrie molto complesse e tolleranze severe. Il nostro staff tecnico interagisce con i nostri clienti dall'inizio del progetto al fine di trovare la giusta soluzione tecnico/produttiva, il reparto è in grado

to produce prototype tools in short time. The use of special steels and new alloys, with specific surface treatment as well as being an added value in terms of quality and reliability, allow Elastotech to work with any kind of raw material in full compliance with customer requirements.

di approntare stampi per l'attività di prototipazione in breve tempo. L'impiego di acciai speciali e nuove leghe con trattamenti superficiali specifici oltre ad essere un valore aggiunto in termini di qualità ed affidabilità stampo, permettono di processare ogni tipo di materia prima nel pieno rispetto delle richieste del cliente.





# RAW MATERIAL WAREHOUSE MAGAZZINO MESCOLE



AUTOMATIC  
TEMPERATURE  
CONTROL

CONTROLLO  
TEMPERATURA  
AUTOMATICA

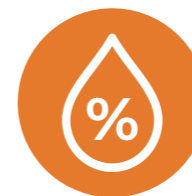

HUMIDITY  
CONTROL

CONTROLLO  
UMIDITÀ



500 SQM

SUPERFICIE  
500 MQ



BATCHES  
ROTATION

ROTAZIONE  
LOTTI



IT MANAGEMENT

GESTIONE  
INFORMATIZZATA

The raw material is stored in a thermo-regulated warehouse, which guarantees relative humidity and constant temperature in every season of the year. The fully computerized management check the availability of raw material and thanks to the FIFO assure proper rotation to the batches. In order to manage any possible emergency of our customer, Elastotech provide a safety stock for the bestsellers polymers.

La materia prima viene conservata in un magazzino termo controllato, che garantisce un'umidità relativa e temperature costante in ogni periodo dell'anno. La gestione completamente informatizzata monitora costantemente la disponibilità della materia prima e mediante il FIFO garantiamo una corretta rotazione dei lotti. Al fine di gestire al meglio ogni possibile emergenza dei nostri clienti Elastotech ha deciso di disporre di stock di sicurezza per le matrici polimeriche alto rotanti.





The Elastotech production process is divided into 6 phases. Once the realization of the tool in the internal workshop is finished, the equipment is assembled in the molding machine: now begins the most important and delicate phase, the production through injection molding.

After this, the seal enters in the department dedicated to finishing and post curing processes and at the end the sorting department where they are checked, eventuali treated superficially before being packed.

Some customers, especially when the number of gaskets produced is very high, take advantage of the storage and collection service.

Il processo produttivo di Elastotech si divide di 6 fasi. Una volta terminata la realizzazione dello stampo nell'officina interna l'attrezzatura viene montata in macchina: inizia così la fase più importante e delicata, la produzione tramite stampaggio.

A seguire la guarnizione entra nel reparto dedicato ai processi di finitura dopodiché passerà al reparto di post vulcanizzazione per poi finire il suo iter in cernita dove viene ispezionata prima di essere all'occorrenza trattata ed infine confezionata.

Alcuni clienti, soprattutto quando il numero di guarnizioni prodotte è molto elevato, usufruiscono del servizio di stoccaggio e ritiro a chiamata.

# PRODUCTION PROCESS

## PROCESSO PRODUTTIVO

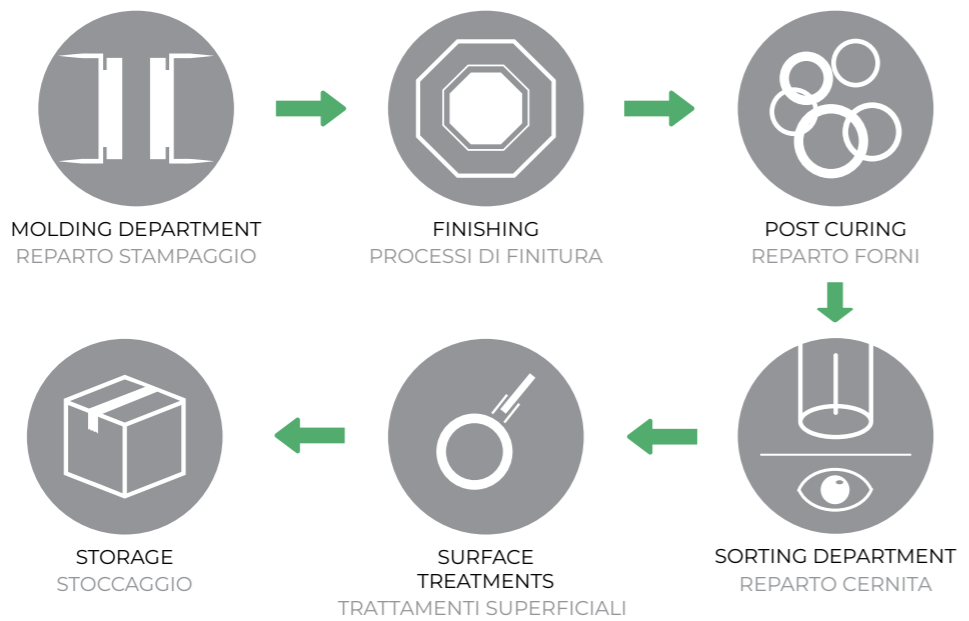



# MOLDING DEPARTMENT

## REPARTO STAMPAGGIO



25 PRESSES

25 PRESSE



INTERCONNECTED  
MANAGEMENT

GESTIONE  
INTERCONNESSA



DIFFERENT PRESS  
TONNAGES

DIFFERENZIATIONE  
TONNELLAGGI



LOW  
EMISSIONS

BASSE  
EMISSIONI



PRESSES FOR  
SAMPLES

PRESSE PER  
CAMPIONATURE

We use injection and compression molds, with molding technology at 4-8-16 and 32 nozzles and thermoregulated plates. Our presses have a tonnage ranging from 180 to 650 tons, which enable us to produce items with huge dimensions and consistent weight. We take care to the ordinary and extraordinary maintenance for the proper functioning of the presses, to ensure the highest quality standard required by our customers.

Utilizziamo stampi a iniezione e compressione con tecnologia di stampaggio a 4-8-16 e 32 ugelli e piani termoregolati. Le presse hanno un tonnellaggio che va da 180 a 650 tonnellate, che ci permettono di stampare articoli con dimensioni e grammature importanti. Siamo attenti alla manutenzione ordinaria e straordinaria per il buon funzionamento delle presse per garantire la massima qualità alle complesse specifiche richieste dai nostri clienti.





# FINISHING PROCESSI DI FINITURA



**CRYOGENIC DEBURRING**  
During cryogenic blasting deburring, the components to be processed are subcooled in a processing room with a suitable coolant, and therefore the burrs become brittle, and are blasted with a blasting medium.

**SBAVATURA CRIOGENICA**  
Per effettuare la granigliatura criogenica i pezzi da sbavare vengono posti all'interno della macchina e raffreddati per mezzo di un refrigerante idoneo: questo rende fragili le bave che saranno poi soggette all'azione della graniglia.



**TUMBLING**  
Tumbling is performed with special octagonal metal containers (called "tumblers"), water and stones (with various sizes); during the rotation, flashes are removed and the residues of molding from the pieces.

**BURATTATURA**  
La rettifica a buratto è eseguita all'interno di speciali contenitori metallici ottagonali ("buratti") contenenti acqua e ghiaia di varia granulometria; grazie allo sfregamento con movimento rotatorio degli inerti contro i manufatti in gomma vengono rimosse le bave ed i residui di stampaggio dai pezzi stessi.

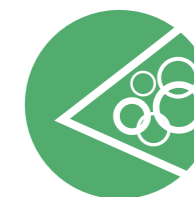

**VIBRATING SCREEN**  
special vibrating tables (vibrating screens), which allows to eliminate the aggregates remained and impurities

**VIBROVAGLIO**  
banchi vibranti (vibrovagli) permettono di eliminare gli inerti rimasti e le impurità





# SURFACE TREATMENTS

## TRATTAMENTI SUPERFICIALI



**COATING TREATMENT**  
PTFE, teflon coating for water contact certification, silicone coating, molycot treatment, talc treatment, plasma treatment

**TRATTAMENTI SUPERFICIALI**  
plasma, teflonatura inerenti alle omologhe a contatto con acqua, talcatura, siliconatura, molicottatura, grafitatura



**HIGH PRESSURE WASHING**  
Washing machines with high pressure water jet system

**LAVAGGIO ALTA PRESSIONE**  
Lavatrici con sistema di lavaggio ad alta pressione.



**TYPE OF TREATMENT REQUIRED FROM CUSTOMER**  
We can offer dedicated surface treatment following the european food and water directive

**TRATTAMENTI SUPERFICIALI SU SPECIFICA RICHIESTA DEL CLIENTE**  
Possiamo offrire trattamenti dedicati conformi alle linee guida per acqua potabile e alimentari





# POST CURING REPARTO FORNI



POST CURING

VULCANIZZAZIONE



ROTARY OVEN

FORNI ROTATIVI



DEDICATED  
MANAGEMENT IT  
SYSTEM

SOFTWARE DEDICATO  
DI CONTROLLO/GESTIONE

Elastotech believes that the post curing process is crucial to give their items excellent mechanical and physical characteristics as well as to fully ensure compliance of the product according to the international regulations. Equipped with 6 calibrated ovens, periodically maintained, divided into static

Elastotech ritiene il processo di post-curing determinante per conferire ai propri manufatti ottime caratteristiche fisico meccaniche oltre a garantire appieno la conformità di prodotto in accordo alle normative internazionali sempre più severe. Dotato di 6 forni debitamente tarati e sottoposti a rigida manutenzione periodica, suddivisi in statici e rotativi, assi-

and rotary, it ensures excellent uniformity in the process. Elastotech certifies each cycle through an external software of latest generation, that check the product from the start to the end of the process. The traceability allows to evaluate any graphic of our products even after several years.

cura un'ottima omogeneità di processo. Elastotech certifica ogni singolo ciclo mediante un apparato software esterno di ultima generazione che monitora il prodotto dall'inizio alla fine del processo. La rintracciabilità del sistema permette di valutare qualsiasi tracciato grafico di tutti i nostri prodotti anche dopo diversi anni.







# SORTING DEPARTMENT

## REPARTO CERNITA



100%  
VISUAL INSPECTION  
100%  
ISPEZIONE VISIVA



DIMENSIONAL  
INSPECTION  
CONTROLLO  
DIMENSIONALE



STATISTICS /  
REPORT  
STATISTICHE  
REPORT



ARTIFICIAL  
INTELLIGENCE  
INTELLIGENZA  
ARTIFICIALE

Elastotech dispone di un reparto dedicato alla cernita automatica al 100% mediante macchine di ultima generazione a visione artificiale. L'upgrade introdotto recentemente ci permette di ispezionare articoli a disegno con forme geometriche complesse. La continua ricerca di tecnologie avanzate ci permette di garantire elevate prestazioni qualitative a prezzi competitivi.

Elastotech has a department dedicated to the 100% automatic sorting by the latest generation of artificial vision. The last upgrade allows us to inspect complex designed items. The ongoing research of advanced technologies enables us to ensure high quality performances at competitive prices.





# STORAGE AND PACKAGING

## STOCCAGGIO E CONFEZIONAMENTO



Our warehouse ensure an optimal condition for the preservation of the material. With an increasingly demanding market, we have a stock of high rotating items certified by our quality system. This allows us to “support” the customer in case of an immediate request. We also guarantee a safety stock for customer who works with program

orders, to better respond to sudden evolution of the market.

The packaging department has automatic packaging machines that allow the boxes containing the seals to be prepared quickly. They are able to process different sizes of items, from the smallest rubber item to the largest one.

L'ambiente predisposto allo stoccaggio delle guarnizioni assicura una condizione ottimale per il mantenimento del materiale. Con un mercato sempre più esigente a livello di servizio, disponiamo di uno stock di articoli alto rotanti certificati dal nostro sistema qualità. Questo ci permette di “sostenere” il cliente di fronte ad una richiesta immediata. Inoltre garantiamo uno stock di sicurezza per i clienti che lavorano con ordini a programma per poter affrontare al meglio una richiesta ad una evoluzione improvvisa del mercato.

preparare in modo veloce ed estremamente preciso le scatole che contengono le guarnizioni. Esse sono in grado di processare diverse dimensioni di articoli, dall'articolo in gomma più piccolo a quello di dimensioni più importanti.

Il reparto di confezionamento ha al suo interno confezionatrici automatiche che permettono di

preparare in modo veloce ed estremamente preciso le scatole che contengono le guarnizioni. Esse sono in grado di processare diverse dimensioni di articoli, dall'articolo in gomma più piccolo a quello di dimensioni più importanti.



## SECTORS OF APPLICATION SETTORI DI APPLICAZIONE

Elastotech, thanks to its technical department provides a service design. We are able to develop design of the item and its tool through exchange of information between customer and our technical office. At request, we carry out pilot tool for approval of samples and we build series production tool and pieces from series production. We are focused on customer's request and we can offer competitive service of research of new applications thanks to the use of the most advanced working technologies.

Elastotech mette a disposizione anche un servizio di progettazione a disegno grazie ad un ufficio interno dedicato. Attraverso un continuo scambio d'informazioni tra progettista e committente viene studiato il prodotto in ogni suo particolare. Successivamente si realizza uno stampo pilota per l'approvazione dei campioni e di seguito la produzione dei pezzi. L'azienda ha a cuore le richieste del cliente, offrendo un servizio competitivo ed esplorando nuovi campi di applicazione della gomma grazie alle tecnologie di lavoro più avanzate.



HYDRO SANITARY  
IDROSANITARIA



FLUIDS CONTROL  
DISTRIBUZIONE IDRICA



HEATING



GAS FLOW AND REGULATION



HYDRAULICS AND PNEUMATICS



HOUSEHOLDS



AUTOMOTIVE  
AUTOMOTIVE

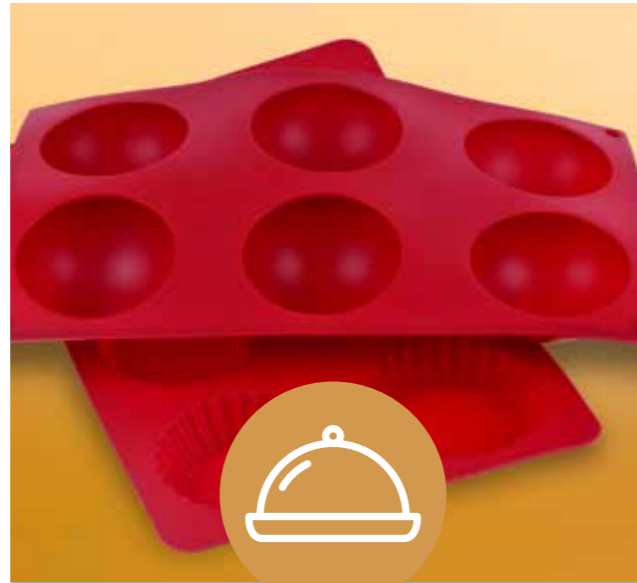

FOOD  
FOOD

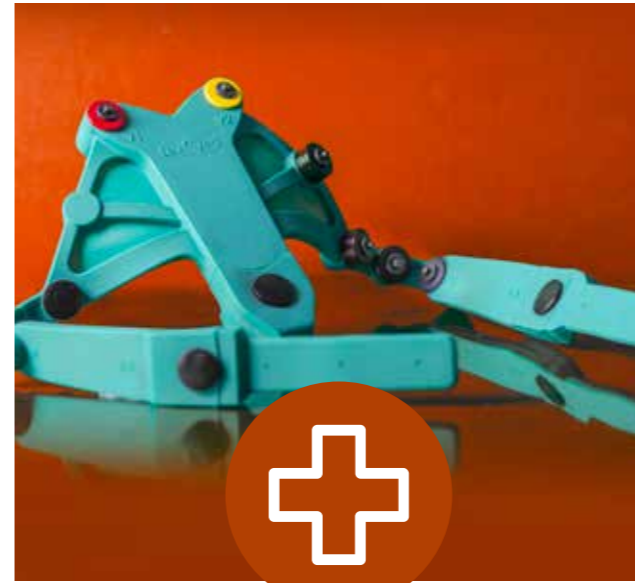

MEDICAL  
MEDICALE



CUSTOM DIVISION  
CUSTOM DIVISION





ELASTOTECH  
elastomers technology



“

*The consumer is the most important point on the production-line  
I clienti sono la parte più importante del nostro ciclo produttivo*

*(Edwards Deming)*

”

E L A S T O T E C H  
elastomers technology

E L A S T O T E C H  
elastomers technology



**ELASTOTECH s.r.l.**  
Via Provinciale 92/94  
24060 Castelli Calepio (BG) - Italy  
Tel. +39 035.4496000  
Fax +39 035.4496037

[www.elastotech.it](http://www.elastotech.it)  
[info@elastotech.it](mailto:info@elastotech.it)